 **TSR**

 **Asphalt shingles**

 **14°–60°**
3:12 – 20:12

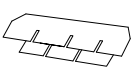

ELEVATION

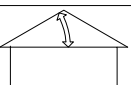
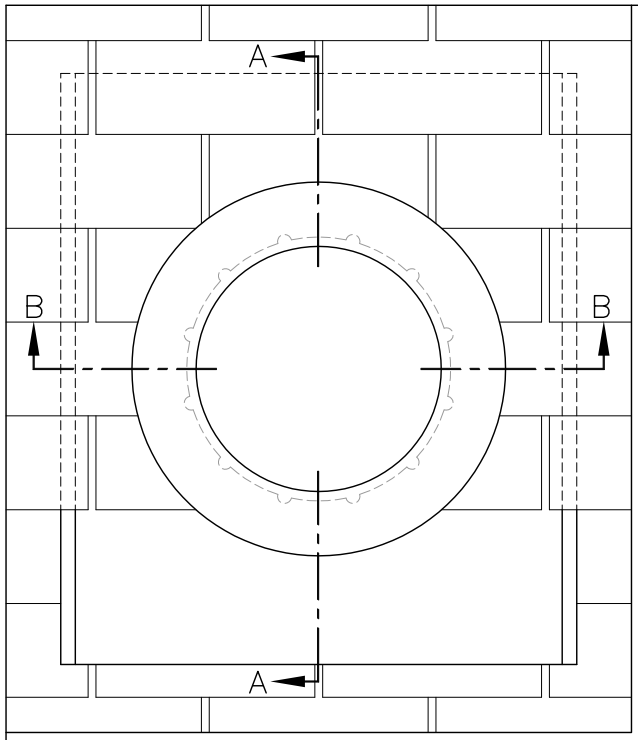
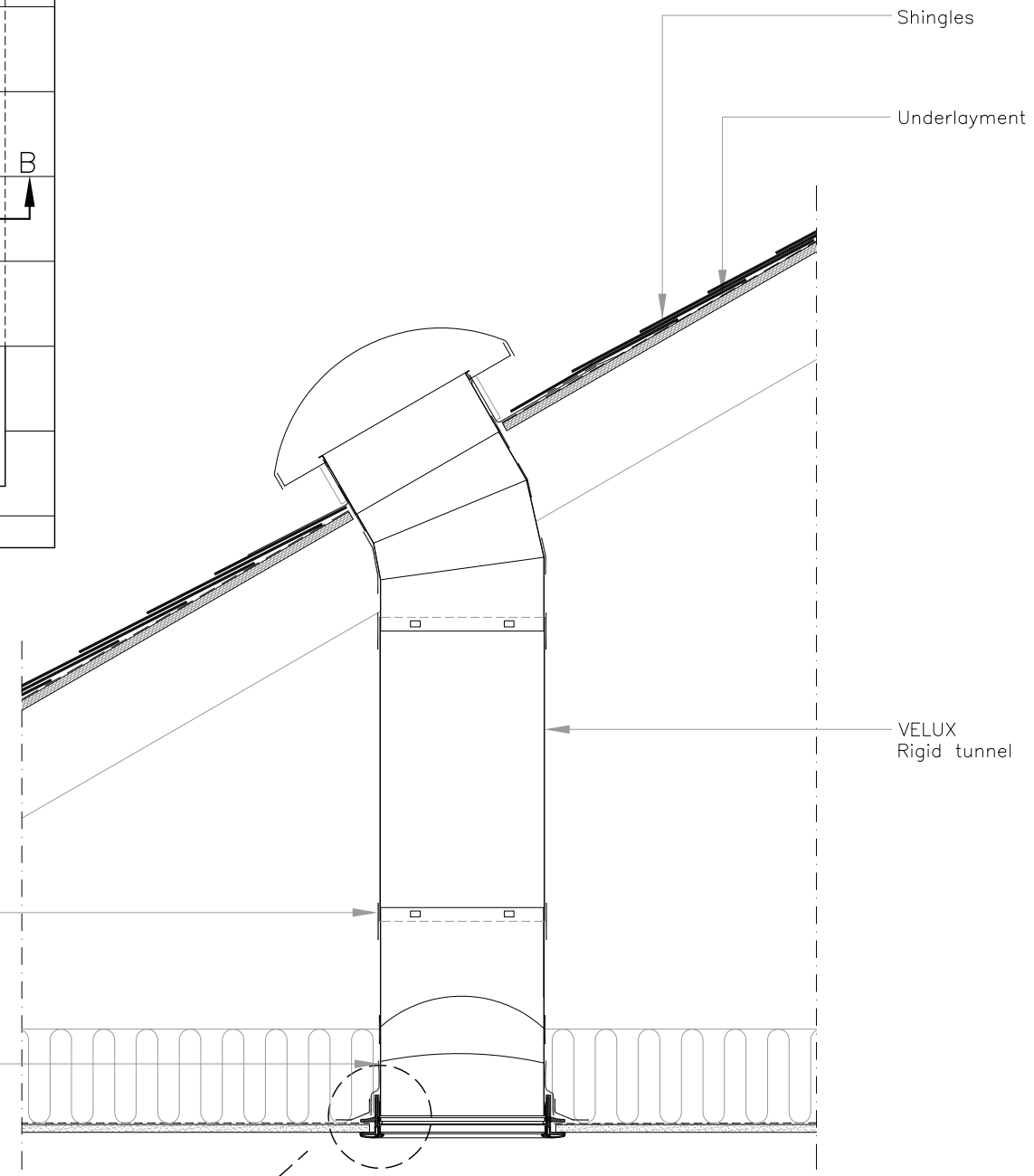

SECTION A-A

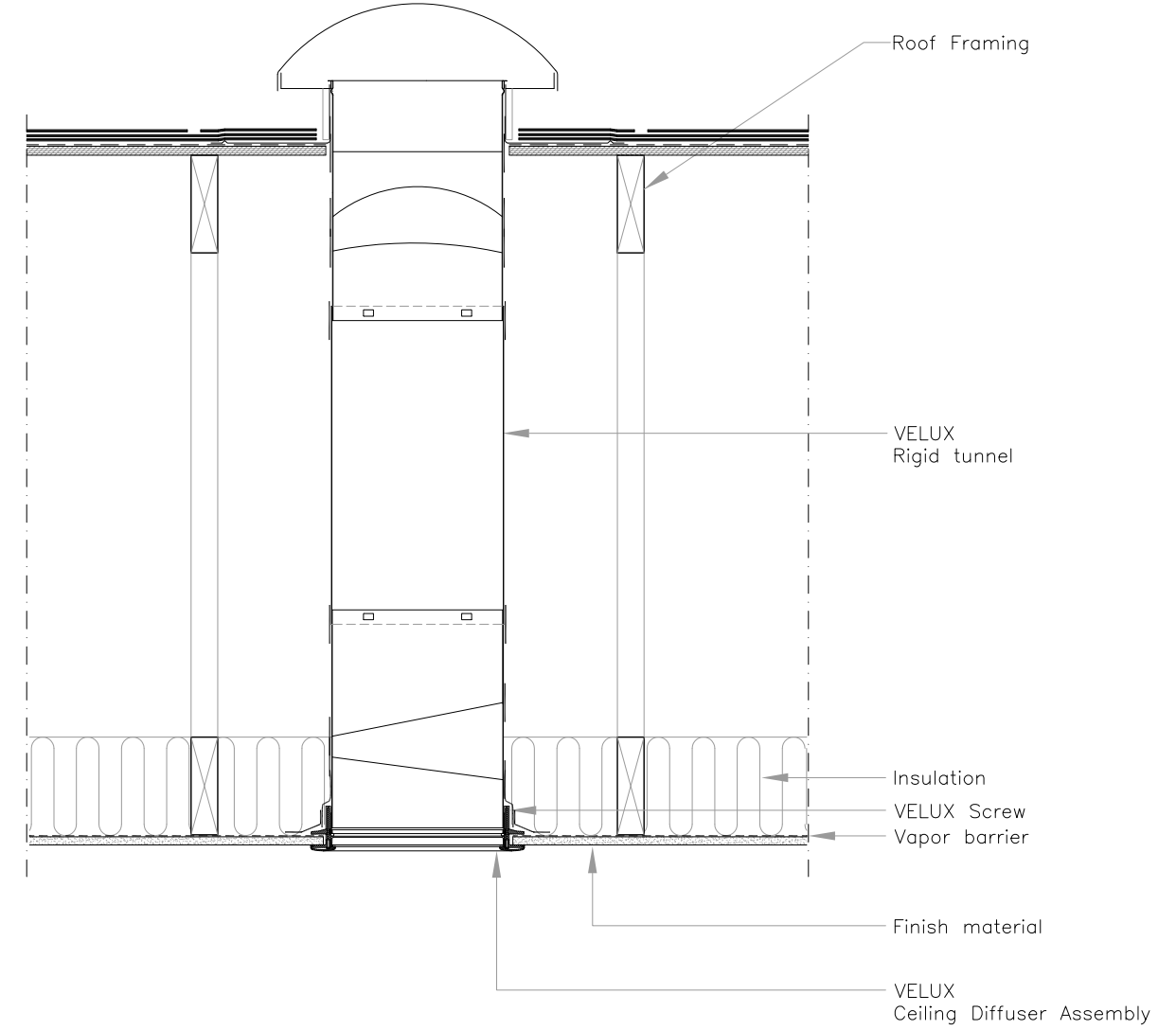
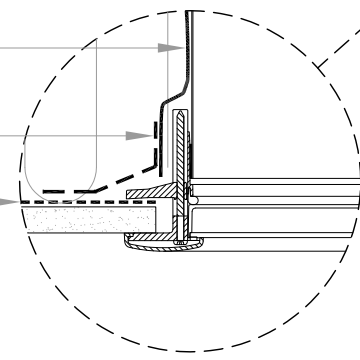

SECTION B-B

 Sky-Product Management	VELUX 1418 Evans Pond Road Greenwood, SC 29649 1-800-88-VELUX www.VELUXUSA.com	<table border="1"> <tr> <th>Name</th> <th>Date</th> </tr> <tr> <td>JDH</td> <td>Dec 2013</td> </tr> <tr> <td>CJ, JL</td> <td>Dec 2013</td> </tr> </table>	Name	Date	JDH	Dec 2013	CJ, JL	Dec 2013
	Name	Date						
JDH	Dec 2013							
CJ, JL	Dec 2013							
TSR 010 – VELUX SUN TUNNEL for Asphalt Shingle Roof		Drawing No. TSR-01-1213						

This drawing is an instrument of service and is provided for informational use only.